

Алматы (7273)495-231	Калининград (4012)72-03-81	Омск (3812)21-46-40	
Ангарск (3955)60-70-56	Калуга (4842)92-23-67	Орел (4862)44-53-42	
Архангельск (8182)63-90-72	Кемерово (3842)65-04-62	Оренбург (3532)37-68-04	Сыктывкар (8212)25-95-17
Астрахань (8512)99-46-04	Киров (8332)68-02-04	Пенза (8412)22-31-16	Тамбов (4752)50-40-97
Барнаул (3852)73-04-60	Коломна (4966)23-41-49	Петрозаводск (8142)55-98-37	Тверь (4822)63-31-35
Белгород (4722)40-23-64	Кострома (4942)77-07-48	Псков (8112)59-10-37	Тольятти (8482)63-91-07
Благовещенск (4162)22-76-07	Краснодар (861)203-40-90	Пермь (342)205-81-47	Томск (3822)98-41-53
Брянск (4832)59-03-52	Красноярск (391)204-63-61	Ростов-на-Дону (863)308-18-15	Тула (4872)33-79-87
Владивосток (423)249-28-31	Курск (4712)77-13-04	Рязань (4912)46-61-64	Тюмень (3452)66-21-18
Владикавказ (8672)28-90-48	Курган (3522)50-90-47	Самара (846)206-03-16	Ульяновск (8422)24-23-59
Владимир (4922)49-43-18	Липецк (4742)52-20-81	Саранск (8342)22-96-24	Улан-Удэ (3012)59-97-51
Волгоград (844)278-03-48	Магнитогорск (3519)55-03-13	Санкт-Петербург (812)309-46-40	Уфа (347)229-48-12
Вологда (8172)26-41-59	Москва (495)268-04-70	Саратов (845)249-38-78	Хабаровск (4212)92-98-04
Воронеж (473)204-51-73	Мурманск (8152)59-64-93	Севастополь (8692)22-31-93	Чебоксары (8352)28-53-07
Екатеринбург (343)384-55-89	Набережные Челны (8552)20-53-41	Симферополь (3652)67-13-56	Челябинск (351)202-03-61
Иваново (4932)77-34-06	Нижний Новгород (831)429-08-12	Смоленск (4812)29-41-54	Череповец (8202)49-02-64
Ижевск (3412)26-03-58	Новокузнецк (3843)20-46-81	Сочи (862)225-72-31	Чита (3022)38-34-83
Иркутск (395)279-98-46	Ноябрьск (3496)41-32-12	Ставрополь (8652)20-65-13	Якутск (4112)23-90-97
Казань (843)206-01-48	Новосибирск (383)227-86-73	Сургут (3462)77-98-35	Ярославль (4852)69-52-93
	Киргизия (996)312-96-26-47	Россия (495)268-04-70	Казахстан (772)734-952-31

Hand towed Battery Pallet Stacker KBE 1000/2,0

Standard equipment

- Light duty application
- Hand towed and Battery powered Lifting/Lowering
- Capacity – **1000 kg**
- Lifting height – **2,0 m**
- DC pump motor – 2 kW
- Traction Battery 2x12V/90 Ah C5
- Automatic on-board charger 24V/15 A
- Battery discharge indicator
- Load backrest
- Steering device
- Castor wheels – Polyurethane (right Drive side – with brake)
- Load side - Tandem rollers Polyamide/ as standard
- Robust Two stage mast with central cylinder

Optional equipment

- Modified Chassis (Straddle legs version)

Hand towed Battery Operated Pallet Stacker KBE 1000/2,0

Type sheet for industrial Trucks according to VDI 2198

		VENI			
Characteristics	1.1	Manufacturer			KBE 1000/2,0
	1.2	Manufacturer's type designation			Battery
	1.3	Power unit			Hand towed
	1.4	Operation			Battery lifting/lowering
	1.5	Load capacity	Q	(kg)	1000
	1.6	Load centre	c	(mm)	600
	1.8	Axle centre to fork face	x	(mm)	690
	1.9	Wheelbase	y	(mm)	1088
	Weight	2.1	Service weight incl. battery		(kg)
Wheels/tyres	3.1	Tyres front/rear (Polyurethane/PU, Polyamide/PA)			PU/PA
	3.2	Tyre size, front		(mm)	D 200x50
	3.3	Tyre size, rear		(mm)	D 82x70
	3.5	Wheels, number front / rear (x=driven)		(mm)	2/4
	3.6	Track width, front	b₁₀	(mm)	688
	3.7	Track width, rear	b₁₁	(mm)	400
Dimensions	4.2	Height, mast lowered	h₁	(mm)	1560
	4.3	Free lift	h₂	(mm)	120
	4.4	Lift	h₃	(mm)	1910
	4.5	Height, mast extended	h₄	(mm)	2460
	4.9	Height of tiller in drive position min./max.	h₁₄	(mm)	1160
	4.15	Fork height, lowered	h₁₃	(mm)	90
	4.151	Fork height, lifted	h₃+h₁₃	(mm)	2000
	4.19	Overall length	l₁	(mm)	1800
	4.20	Length to fork face	l₂	(mm)	650
	4.21	Overall width	b₁	(mm)	800
	4.22	Fork dimensions	s/e/l	(mm)	55/165/1150
	4.25	Overall forks width	b₅	(mm)	560
	4.32	Ground clearance, centre of wheelbase	m₂	(mm)	40
	4.34	Aisle width with pallet 800x1200 mm along forks	Ast	(mm)	2410
4.35	Turning radius	Wa	(mm)	1700	
4.36	Internal turning radius	b₁₃	(mm)	840	
Performance	5.2	Lifting speed, with/ without load		(m/s)	0.136/0.160
	5.3	Lowering speed, with/ without load		(m/s)	0.168/0.134
Drive	6.2	Lift motor rating S3 15%		(kW)	2.0
	6.4	Battery voltage/ rated capacity C5		(V/Ah)	2x12-24/90

KBE 1000/2,0

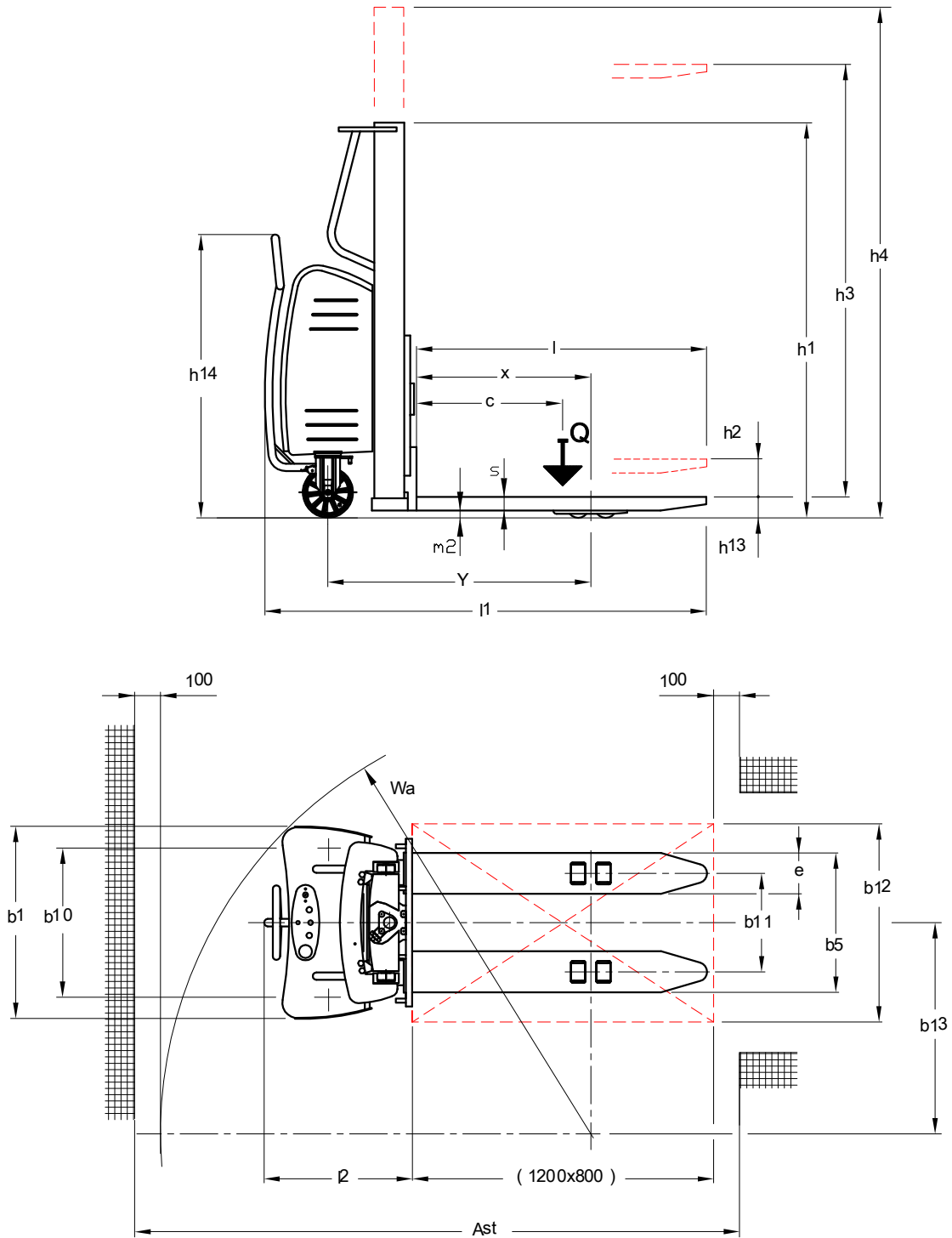

VDI 2198 - Four wheel Forklift Truck top view,
reduced load width - $b_{12} / 2 \leq b_{13}$

Алматы (7273)495-231
Ангарск (3955)60-70-56
Архангельск (8182)63-90-72
Астрахань (8512)99-46-04
Барнаул (3852)73-04-60
Белгород (4722)40-23-64
Благовещенск (4162)22-76-07
Брянск (4832)59-03-52
Владивосток (423)249-28-31
Владикавказ (8672)28-90-48
Владимир (4922)49-43-18
Волгоград (844)278-03-48
Вологда (8172)26-41-59
Воронеж (473)204-51-73
Екатеринбург (343)384-55-89
Иваново (4932)77-34-06
Ижевск (3412)26-03-58
Иркутск (395)279-98-46
Казань (843)206-01-48

Калининград (4012)72-03-81
Калуга (4842)92-23-67
Кемерово (3842)65-04-62
Киров (8332)68-02-04
Коломна (4966)23-41-49
Кострома (4942)77-07-48
Краснодар (861)203-40-90
Красноярск (391)204-63-61
Курск (4712)77-13-04
Курган (3522)50-90-47
Липецк (4742)52-20-81
Магнитогорск (3519)55-03-13
Москва (495)268-04-70
Мурманск (8152)59-64-93
Набережные Челны (8552)20-53-41
Нижний Новгород (831)429-08-12
Новокузнецк (3843)20-46-81
Ноябрьск (3496)41-32-12
Новосибирск (383)227-86-73
Киргизия (996)312-96-26-47

Омск (3812)21-46-40
Орел (4862)44-53-42
Оренбург (3532)37-68-04
Пенза (8412)22-31-16
Петрозаводск (8142)55-98-37
Псков (8112)59-10-37
Пермь (342)205-81-47
Ростов-на-Дону (863)308-18-15
Рязань (4912)46-61-64
Самара (846)206-03-16
Саранск (8342)22-96-24
Санкт-Петербург (812)309-46-40
Саратов (845)249-38-78
Севастополь (8692)22-31-93
Симферополь (3652)67-13-56
Смоленск (4812)29-41-54
Сочи (862)225-72-31
Ставрополь (8652)20-65-13
Сургут (3462)77-98-35
Россия (495)268-04-70

Сыктывкар (8212)25-95-17
Тамбов (4752)50-40-97
Тверь (4822)63-31-35
Тольятти (8482)63-91-07
Томск (3822)98-41-53
Тула (4872)33-79-87
Тюмень (3452)66-21-18
Ульяновск (8422)24-23-59
Улан-Удэ (3012)59-97-51
Уфа (347)229-48-12
Хабаровск (4212)92-98-04
Чебоксары (8352)28-53-07
Челябинск (351)202-03-61
Череповец (8202)49-02-64
Чита (3022)38-34-83
Якутск (4112)23-90-97
Ярославль (4852)69-52-93
Казахстан (772)734-952-31